

JK-储能系列BMS产品规格书

JK-Energy Storage Series BMS Product Specification

锂电池主动均衡保护板

Lithium battery active balancing protection board

JK-PB1A16S-10P

JK-PB1A16S-15P

JK-PB2A16S-15P

JK-PB2A16S-20P

版本：15.4.1

Version: 15.4.1

成都极空科技有限公司

Chengdu Jikong Technology Co.LTD

1. 产品概述(Product Overview) .....	5
1.1. BMS概述(BMS Overview) .....	5
1.2. 功能特性(Functional characteristics) .....	6
1.3. 结构框图(Structural block diagram) .....	7
2. 产品选型指南(Product selection guide) .....	8
2.1. 产品功能配置表(Product function configuration table) .....	8
2.2. 产品适配指南(Product adaptation guide) .....	9
3. 功能介绍及使用说明(Function introduction and usage instructions) .....	10
3.1. 主动均衡(Active equalization) .....	10
3.2. 显示屏接口(Display interface) .....	10
3.3. 加热功能(Heating function) .....	10
3.4. 干接点功能(Dry contact function) .....	11
3.5. 充电过压保护及恢复(Charge overvoltage protection and recovery) .....	12
3.6. 放电欠压保护及恢复(Discharge undervoltage protection and recovery) .....	12
3.7. 充电过流保护及恢复(Charge overcurrent protection and recovery) .....	12
3.8. 放电过流保护及恢复(Discharge overcurrent protection and recovery) .....	13
3.9. 过温保护及恢复(Over temperature protection and recovery) .....	13
3.10. 低温保护及恢复(Low temperature protection and recovery) .....	13
3.11. 短路保护及恢复(Short circuit protection and recovery) .....	14
3.12. 应急开关(Emergency switch) .....	14
3.13. 智能休眠(Intelligent sleep) .....	15
3.14. 通信功能(Communication function) .....	15
3.15. 充电限流功能(Charge current limiting function) .....	15
3.16. 接口板功能介绍(This section describes the functions of the interface board) .....	16
4. 主要参数(Main parameter) .....	17
4.1. 基本参数(Basic parameter) .....	17
4.2. 默认参数(Default parameters) .....	18
5. 接口定义(Interface definition) .....	20
5.1. 产品外形 (Product Appearance) .....	20
5.2. 产品连接器、LED 定义(Product connector, LED definition) .....	21
5.3. 产品尺寸(Product size) .....	27
5.4. 安装方法 (Installation method) .....	29
6. 设备使用说明(APP operation Instructions) .....	30
6.1. APP安装 (APP installation) .....	30

6.2. 设备激活(Device activation) .....	31
6.3. 参数设置(Parameter setting) .....	31

## 版本修改记录

修订日期	版本号	修订概要	作者
2024.5.28	V15.4.1	首次发布	李梦飞

## 1. 产品概述(Product Overview)

### 1.1. BMS概述(BMS Overview)

锂电池智能保护板是为大容量串联锂电池组量身打造的管理系统，具备电压采集、大电流主动均衡、过充过放过流过温保护、库仑计、蓝牙通信、上位机监控等功能。可适用于磷酸铁锂、三元锂等电池种类。

Lithium battery intelligent protection board is a management system tailored for large capacity series lithium battery pack, with voltage acquisition, high current active balancing, overcharge over pass temperature protection, coulomb meter, Bluetooth communication, host computer monitoring and other functions. Can be applied to lithium iron phosphate, ternary lithium battery type.

保护板依托具备自主知识产权的能量转移式主动均衡技术，可以实现最大持续 1/2A 的均衡电流。大电流主动均衡技术可以最大程度的保证电池一致性、提高电池续航里程、延缓电池衰老。

The protection board relies on the energy transfer active balancing technology with independent intellectual property rights, which can achieve A maximum continuous 1/2A balance current. The high current active equalization technology can ensure the consistency of the battery to the greatest extent, improve the battery range and delay the aging of the battery.

保护板有配套的手机APP，支持 Android 和 IOS 操作系统。APP 可以通过手机蓝牙连接到保护板以查看电池工作状态、修改保护板的各项工作参数、控制充放电开关等等。保护板体积小、操作简单、功能全，可广泛应用于大功率储能、基站备用电源、太阳能电站等产品的电池 PACK。

The protection board has a mobile APP supporting Android and IOS operating systems. The APP can be connected to the protection board through the Bluetooth of the mobile phone to check the working status of the battery, modify the working parameters of the protection board, control the charge and discharge switch, and so on. The protection board has small size, simple operation and full functions, and can be widely used in the battery PACK of high-power energy storage, base station backup power supply, solar power station and other products.

## 1.2. 功能特性(Functional characteristics)

- LED蓝牙状态指示
- APP蓝牙远程操作
- 电池容量计算
- 支持PC端操作
- 高精度电压采集( $\pm 3\text{mV}$ )
- 高精度电流采集
- 支持信息屏幕显示
- 精准时间日志记录
- 支持RS485通信
- 支持CAN通信
- 支持加热功能
- 报警干接点功能
- 充电过流保护
- 充电过压保护
- 充电过温保护
- 充电低温保护
- 放电过流保护
- 放电欠压保护
- 放电过温保护
- 短路保护功能
- 电池并联限流功能
- LED Bluetooth status indicator
- APP Bluetooth remote operation
- Battery capacity calculation
- Supports PC operations
- High precision voltage acquisition ( $\pm 3\text{mV}$ )
- High precision current acquisition
- Support information screen display
- Accurate time logging
- Support RS485 communication
- Support CAN communication
- Support heating function
- Alarm dry contact function
- Charge overcurrent protection
- Charge overvoltage protection
- Charge over temperature protection
- Low temperature protection during charge
- Discharge overcurrent protection
- Discharge undervoltage protection
- Discharge over temperature protection
- Short circuit protection
- Battery parallel current limiting function

### 1.3. 结构框图(Structural block diagram)

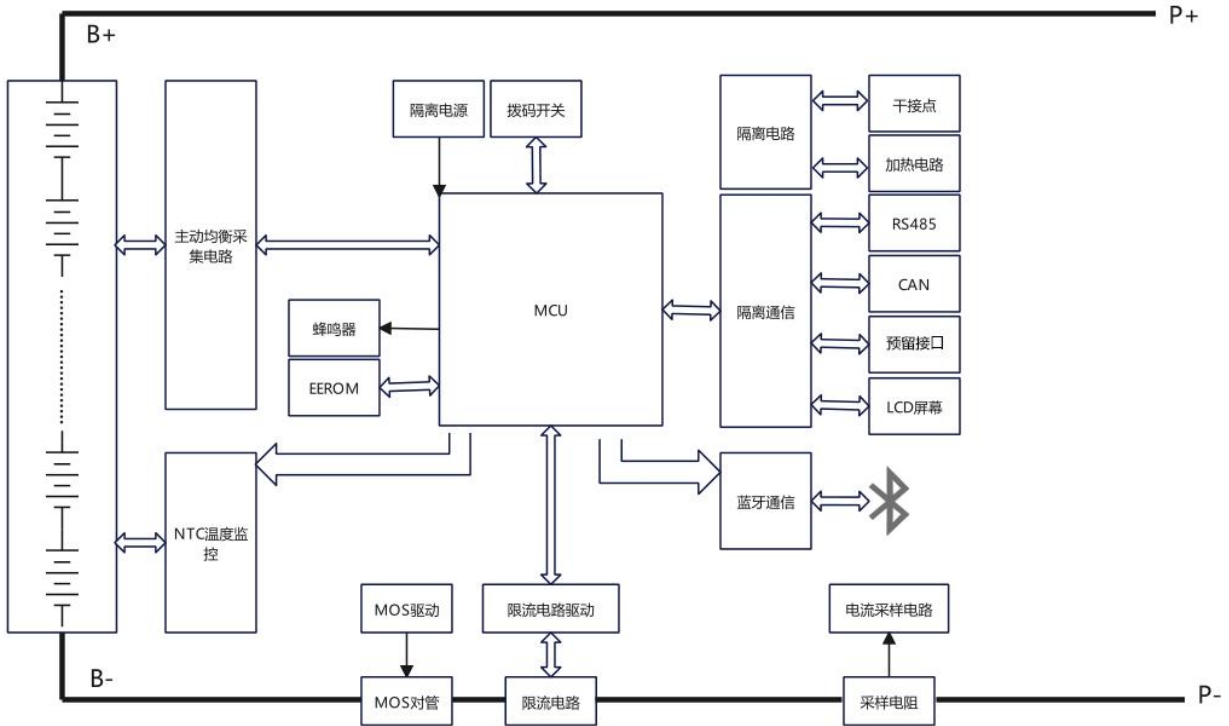

JK-PB1/2A16S-10/15/20P 结构框图

JK-PB1/2A16S-10/15/20P structure block diagram

## 2. 产品选型指南(Product selection guide)

### 2.1. 产品功能配置表(Product function configuration table)

产品规格 (Product specification)	JK-PB1/2A16S-10/15/20P		
序号 (Serial number)	功能 (Function)	配置 (Configuration)	
1	主动均衡电流 (Active equalizing current)	JK-PB1A16S-10P	1A
		JK-PB1A16S-15P	
		JK-PB2A16S-15P	2A
		JK-PB2A16S-20P	
2	蓝牙功能 (Bluetooth function)	标配 (Standard option)	
3	NTC数量 (NTC quantity)	1路内置, 4路外置 (1 built-in, 4 external)	
4	RS485	标配2路 (Two channels are standard)	
5	CAN	标配 (Standard option)	
6	显示屏接口 (Display interface)	标配 (Standard option)	
7	加热功能 (Heating function)	标配 (Standard option)	
8	干接点功能 (Dry contact function)	标配2路 (Two channels are standard)	
9	充电过压、过流保护 (Charging overvoltage, overcurrent protection)	标配 (Standard option)	
10	放电欠压、过流保护 (Discharge under voltage, over current protection)	标配 (Standard option)	
11	短路保护功能 (Short circuit protection)	标配 (Standard option)	
12	电池并联限流功能 (Battery parallel current limiting function)	标配 (Standard option)	
13	最大持续电流 (Maximum continuous current)	JK-PB1A16S-10P	100A
		JK-PB1A16S-15P	150A
		JK-PB2A16S-15P	
		JK-PB2A16S-20P	200A



## 2.2. 产品适配指南(Product adaptation guide)

序号 (Serial number)	产品规格 (Product specification)	电池类型 (Battery type)	适配串数 (Number of adaptive battery strings)
1	JK-PB1A16S-10P	三元锂电池 (Ternary lithium battery)	8-16
		铁锂电池 (Lithium iron battery)	7-16
		钛酸锂电池 (Lithium titanate battery)	14-16
2	JK-PB1A16S-15P	三元锂电池 (Ternary lithium battery)	8-16
		铁锂电池 (Lithium iron battery)	7-16
		钛酸锂电池 (Lithium titanate battery)	14-16
3	JK-PB2A16S-15P	三元锂电池 (Ternary lithium battery)	8-16
		铁锂电池 (Lithium iron battery)	7-16
		钛酸锂电池 (Lithium titanate battery)	14-16
4	JK-PB2A16S-20P	三元锂电池 (Ternary lithium battery)	8-16
		铁锂电池 (Lithium iron battery)	7-16
		钛酸锂电池 (Lithium titanate battery)	14-16

## 3. 功能介绍及使用说明(Function introduction and usage instructions)

### 3.1. 主动均衡(Active equalization)

保护板采用主动均衡技术，均衡的原理是将高电压的电芯能量转移到低电压的电芯中，通过保护板这一媒介实现能量转移。用户在使用均衡功能之前需要设置电池基本参数，需要下载极空BMS-APP，下载之后在极空APP中参数设置页面设置电池类型，默认参数见第四章。设置完成电池类型后在常用设置中设置电池基本参数，包括单体数量、电池容量、触发均衡压差(可保持默认)、电压校准、电流校准等。

The protection board adopts active equalization technology, and the principle of equalization is to transfer the energy of the high-voltage cell to the low-voltage cell, and realize the energy transfer through the medium of the protection board. Before using the balancing function, users need to set the basic parameters of the battery and download the JIKONG BMS-APP. After downloading, set the battery type on the parameter setting page of the extreme space APP. For default parameters, see Chapter 4. After setting the battery type, set basic battery parameters in common Settings, including the number of cells, battery capacity, trigger equalization differential pressure (the default value can be retained), voltage calibration, and current calibration.

用户可在APP的参数设置中自行设置均衡触发压差(mV)，均衡打开时，当电池包中任意两串电池压差大于设定值时均衡自动打开，压差小于设置值后关闭。默认均衡电流为最大值1A/2A，用户可根据自己电池容量来调整，建议均衡电流不超过电池容量(C)的0.2C。如无需均衡功能，可在APP的BMS控制页中将均衡开关设置为关闭状态。

Users can set the balance trigger pressure difference (mV) in the parameter setting of the APP. When the balance is turned on, the balance will be turned on automatically when the pressure difference of any two strings of batteries in the battery pack is greater than the set value, and the balance will be turned off when the pressure difference is less than the set value. The default balance current is 1A/2A. Users can adjust the balance current according to their own battery capacity. It is recommended that the balance current not exceed 0.2C of the battery capacity (C). If you do not need the balancing function, you can set the balancing switch to off in the BMS control page of the APP.

### 3.2. 显示屏接口(Display interface)

保护板预留了显示屏接口，支持用户选配我司显示屏，方便查看电池信息，用户可根据实际需求进行选配。

The display interface is reserved for the protection board, which supports users to select our display for convenient viewing of battery information. Users can select and select according to actual needs.

### 3.3. 加热功能(Heating function)

保护板标配加热功能，在低温条件下通过电阻加热器或加热膜来为电池加热，避免因低温导致的电池活

性降低而无法充放电，设计加热电流为4A，用户可根据实际需求选配此功能以及功率匹配的加热设备。此功能用户可根据自己所处的的气温实际情况在极空APP中的BMS控制页进行开关操作。同时建议在加热回路中串联一个温控开关作为二级保护，防止极端情况出现热失控。建议选择45℃~65℃常闭型温控开关，当温度达到温控开关阈值后温控开关断开，切断加热回路防止继续加热。

The protection plate comes standard with heating function. The resistance heater or heating film is used to heat the battery at low temperature to avoid the failure of charging and discharging due to the decrease of battery activity caused by low temperature. The designed heating current is 4A. This function allows users to switch operations in the BMS control page of the APP according to their actual temperature. At the same time, it is recommended to series a temperature control switch in the heating circuit as a secondary protection to prevent thermal runaway in extreme cases. You are advised to select a normally closed temperature switch of 45 ° C to 65 ° C. When the temperature reaches the threshold of the temperature switch, the temperature switch is turned off and the heating circuit is cut off to prevent further heating.

### 3.4. 干接点功能(Dry contact function)

保护板标配2路干接点干接点来实现对报警、风扇等外部设备的控制功能，在BMS检测到电池处于过温、过充、过放等状态时报警接口可通过切换干接点的状态来驱动蜂鸣器对外报警或者驱动风扇降温，触发条件用户可以根据自身需求选择其中2项，切换触发报警条件后需要用户根据自身需求对条件进行设置。

The protection board is equipped with two dry contacts to control external devices such as alarms and fans. When the BMS detects that the battery is in overtemperature, overcharge, or overdischarge state, the alarm interface can switch the status of the dry contact to drive the buzzer to alarm or drive the fan to cool down. You can select two trigger conditions based on your requirements. After switching the trigger alarm conditions, users need to set the conditions according to their own needs.

干接点对外部报警设备控制原理图如下所示：

The control principle of dry contact to external alarm equipment is shown in the following figure:

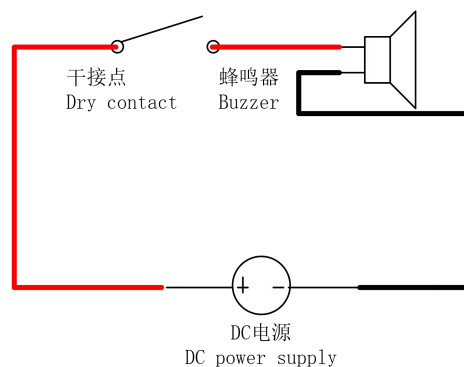

干接点接线图

Dry contact wiring diagram

### 3.5. 充电过压保护及恢复(Charge overvoltage protection and recovery)

保护板标配充电过压保护，用户可以在极空APP中的参数设置页中自行设置单体过充保护电压以及单体过充恢复电压，电池充电时当任意一串电池出现过压后保护板将关闭充电来保护电池，当所有单体电压均低于单体过充恢复电压之后保护板再次开启充电，以防止电池过充从而损坏电芯。

The protection board is equipped with charge overvoltage protection as standard. Users can set the single overcharge protection voltage and single overcharge recovery voltage in the parameter setting page of the APP. When any string of batteries is overvoltage during battery charging, the protection board will turn off the charging to protect the battery. To prevent the battery from overcharging and damaging the cell.

### 3.6. 放电欠压保护及恢复(Discharge undervoltage protection and recovery)

保护板标配放电欠压保护功能，用户可以根据自身电池类型在极空APP中的参数设置页设置电池欠压保护电压(V)、电池欠压恢复电压(V)、自动关机电压(V)。当保护板处于放电状态时，当任意一串电池的电压低于设置的欠压保护电压值，保护板触发欠压保护同时关闭放电来保护电芯，防止过放损坏电芯。当电池充电至所有单体电芯电压均高于欠压恢复电压时，欠压保护解除将再次打开放电。当电池任意一串电芯的电压低于自动关机电压时，保护板将自动关机来保护电芯。

The protection board is equipped with discharge undervoltage protection function as standard. Users can set battery undervoltage protection voltage (V), battery undervoltage recovery voltage (V) and automatic shutdown voltage (V) in the parameter setting page of the APP according to their own battery type. When the protection board is in the discharge state, when the voltage of any string of batteries is lower than the set undervoltage protection voltage value, the protection board triggers the undervoltage protection and closes the discharge at the same time to protect the battery cell and prevent overdischarge from damaging the battery cell. When the battery is charged until the voltage of all individual cells is higher than the undervoltage recovery voltage, the undervoltage protection release will turn on the discharge again. When the voltage of any string of batteries is lower than the automatic shutdown voltage, the protection board will automatically shut down to protect the battery.

### 3.7. 充电过流保护及恢复(Charge overcurrent protection and recovery)

保护板标配充电过流保护功能，用户可以根据自身电池容量以及充电器输出电流自行在极空APP中的参数设置页设置持续充电电流(A)、充电过流延时(S)、充电过流解除(S)。当充电电流大于设置的持续充电电流时，经过设置的充电过流延时时间后触发充电保护，保护板关闭充电，经过充电过流解除时间后保护板将再次打开充电。

The protection board is equipped with the charging overcurrent protection function as standard. Users can set the continuous charging current (A), charging overcurrent delay (S) and charging overcurrent release (S) in the parameter setting page of the APP according to their own battery capacity and the output current of the charger. When the charging current is greater than the set continuous charging current, the charging protection will be

triggered after the set charging overcurrent delay time, and the protection board will close the charging, and the protection board will open the charging again after the charging overcurrent release time.

### 3.8. 放电过流保护及恢复(Discharge overcurrent protection and recovery)

保护板标配放电过流保护功能，用户可以根据自身电池容量以及负载输出电流自行在极空APP中的参数设置页设置持续放电电流(A)、放电过流延时(S)、放电过流解除(S)。当放电电流大于设置的持续放电电流时，经过设置的放电过流延时时间后触发放电过流保护，保护板关闭放电，经过放电过流解除时间后保护板将再次打开放电。

The protection board is equipped with the discharge overcurrent protection function as standard. Users can set the continuous discharge current (A), discharge overcurrent delay (S) and discharge overcurrent release (S) in the parameter setting page of the APP according to their own battery capacity and load output current. When the discharge current is greater than the set continuous discharge current, the discharge overcurrent protection is triggered after the set discharge overcurrent delay time, and the protection board closes the discharge. After the discharge overcurrent release time, the protection board starts the discharge again.

### 3.9. 过温保护及恢复(Over temperature protection and recovery)

保护板标配充放电过温保护功能，用户可以根据自身需求在极空APP中的参数设置页设置充电过温保护(°C)、充电过温恢复(°C)、放电过温保护(°C)、放电过温恢复(°C)。当保护板采集到的温度数据高于设置的设置的充电过温保护值时，保护板关闭充电，当温度恢复到低于设置的充电过温恢复值以下时再次打开充电，放电过温保护以及恢复同理。

The protection board is equipped with charge and discharge overtemperature protection function as standard. Users can set charge overtemperature protection ( °C ), charge overtemperature recovery ( °C ), discharge overtemperature protection ( °C ), and discharge overtemperature recovery ( °C ) on the parameter setting page of the APP according to their own needs. When the temperature data collected by the protection board is higher than the set charge overtemperature protection value, the protection board shuts down the charging, and turns on the charging again when the temperature is lower than the set charge overtemperature recovery value. The same applies to the discharge overtemperature protection and recovery.

### 3.10. 低温保护及恢复(Low temperature protection and recovery)

保护板标配充电低温保护功能，用户可以根据自身需求在极空APP中的参数设置页设置充电低温保护(°C)、充电低温恢复(°C)。当保护板采集到的温度数据低于设置的设置的充电低温保护值时，保护板关闭充电，当温度恢复到高于设置的充电低温恢复值时再次打开充电，建议冬天极寒地区的用户选配加热功能以便更好的保护电芯。

The protection board is equipped with charging low temperature protection function as standard. Users can set

charging low temperature protection ( $^{\circ}\text{C}$ ) and charging low temperature recovery ( $^{\circ}\text{C}$ ) in the parameter setting page of the APP according to their own needs. When the temperature data collected by the protection board is lower than the set charging low temperature protection value, the protection board closes the charging, and turns on the charging again when the temperature returns to higher than the set charging low temperature recovery value. It is recommended that users in extremely cold areas in winter choose the heating function to better protect the battery cell.

### 3.11. 短路保护及恢复(Short circuit protection and recovery)

保护板标配短路保护功能，此项参数无需用户自行设置触发短路保护的电流，用户如果需要可以根据自身需求在极空APP中的参数设置页设置短路保护延时(us)以及短路保护恢复时间(S)。当用户首次连接充电器充电时，外部线路正确连接后，在BMS控制页中打开充电后若触发充电短路保护，可以增大短路保护延时，导致保护的原因为充电器开启输出瞬间峰值电流过大引起，此时经过短路保护恢复时间后短路保护解除，保护板打开充电。当用户初次连接负载使用时出现放电短路保护后，在确保外部接线不存在短路时可通过增加短路保护延时来解决，因为部分负载内部的电容较大导致开启瞬间电流可能较大会导致触发短路保护，此时经过短路保护恢复时间后短路保护解除，保护板打开放电。

The protection board is equipped with the short circuit protection function as standard. The user does not need to set the current that triggers the short circuit protection by himself. If necessary, the user can set the short circuit protection delay (us) and short circuit protection recovery time (S) on the parameter setting page of the APP. When the user connects the charger for the first time to charge, if the charging short circuit protection is triggered after the external line is correctly connected in the BMS control page, the short circuit protection delay can be increased. The cause of the protection is that the peak current of the charger is too large when the charger is turned on and output. In this case, the short circuit protection is lifted after the short circuit protection recovery time, and the protection board is turned on and charged. When the user is connected to the load for the first time, the discharge short-circuit protection occurs, and the short-circuit protection delay can be increased to ensure that there is no short circuit in the external wiring. Because the capacitance inside some loads is large, the opening instantaneous current may be too large, which may trigger the short-circuit protection. In this case, the short-circuit protection is removed after the short-circuit protection recovery time, and the protection board is opened and discharged.

### 3.12. 应急开关(Emergency switch)

保护板标配应急开关功能，当用户正常使用时如果出现过温、过放、过充、掉串等问题时，在极空APP中BMS控制页打开应急开关后，保护板将同时打开充放电30分钟，给予用户一个应急使用时间，在此过程中假如单体电芯电压已到达自动关机电压，保护板也将持续工作直至此次应急开关30分钟周期结束，避免出现在道路上抛锚等险情。

The protection board is equipped with the standard emergency switch function. When the user is in normal use,



if there are problems such as over-temperature, over-discharge, over-charge, and drop string, the protection board will turn on the charge and discharge for 30 minutes at the same time after the emergency switch is opened on the BMS control page in the APP, giving the user an emergency use time. In this process, if the voltage of the single cell has reached the automatic shutdown voltage, the protection board will turn on the charge and discharge for 30 minutes at the same time. The protective plate will also continue to work until the end of the 30-minute emergency switch cycle to avoid dangerous situations such as breaking down on the road.

### 3.13. 智能休眠(Intelligent sleep)

保护板标配智能休眠功能，用户可跟即自身需求在极空APP的BMS控制页选择打开或者关闭。此功能目的为在保护板处于待机状态时(连续26小时充放电电流小于1A)关闭保护板以减少保护板自身对于电池的能量消耗，当用户需要再次激活使用时可以使用按钮激活或者充电器激活即可。

The protection board is equipped with intelligent sleep function as standard, and users can choose to open or close the BMS control page of the APP according to their own needs. The purpose of this function is to close the protection board when the protection board is in standby state (the charging and discharging current is less than 1A for 26 consecutive hours) to reduce the energy consumption of the protection board itself to the battery. When the user needs to activate it again, the button can be activated or the charger can be activated.

### 3.14. 通信功能(Communication function)

保护板标配CAN、RS485通信。CAN通信默认通信速率250K，用户可以根据自己所使用的逆变器品牌与具体规格在极空APP中选择对应的协议。同时具有两路RS45通信接口，其中RS485-1用于与逆变器等设置通信，用户可以根据自己所使用的逆变器品牌与具体规格在极空APP中选择对应的协议。RS485-2并联输出两个接口用于电池包的并联同时连接上位机查看电池组信息，默认波特率115200。保护板可以通过设置拨码开关设置通信地址，可通过上位机轮询查询所有电池包的数据，地址设置范围0~15。

The protection board is equipped with CAN and RS485 communications. The default communication rate of CAN communication is 250K. Users can select the corresponding protocol in the extreme space APP according to their inverter brand and specific specifications. At the same time, there are two RS45 communication interfaces, among which RS485-1 is used for communication with inverters and other Settings, and users can choose the corresponding protocol in the APP according to their own inverter brand and specific specifications. RS485-2 Parallel output Two ports are used to connect battery packs in parallel to the upper computer to view battery string information. The default baud rate is 115200. The protection board can set the communication address by setting the DIP switch, and query the data of all battery packs through the upper polling. The address range is 0 to 15.

### 3.15. 充电限流功能(Charge current limiting function)

保护板标配充电限流功能，用户可以根据自身电池容量以及充电电流在极空APP中设置持续充电电流

(A)、充电过流延时(S)、充电过流解除时间(S)。当电池出现充电过流的情况时候限流功能进入启动，将充电电流恒定在10A左右以保护电池。

The protection board is equipped with the charging current limiting function as standard. Users can set the continuous charging current (A), charging overcurrent delay (S) and charging overcurrent release time (S) in the APP according to their own battery capacity and charging current. When the battery is charged overcurrent, the current limiting function is started, and the charging current is constant at about 10A to protect the battery.

### 3.16. 接口板功能介绍(This section describes the functions of the interface board)

保护板出厂标配接口板以便于用户使用LED指示灯、复位开关、拨码开关、干接点、通信等功能。LED指示灯可协助用户判断当前BMS工作状态、电池剩余电量；复位按键可以在用户使用BMS出现异常时按下复位BMS；拨码开关可用于当BMS用于并联使用环境下的地址设置，支持0-15一共16个地址；干接点用户对报警、风扇等外部设备的控制；CAN与RS485-1用于BMS跟逆变器的通信；RS485-2用于电池包的并联以及与上位机通讯，面板接口如下图(详情见附件)。

Protection board Factory standard interface board for users to use LED indicator, reset switch, dip switch, dry contact, communication and other functions. The LED indicator can help the user judge the current BMS working status and the remaining battery power; The reset button can be pressed to reset the BMS when the user fails to use the BMS. The dip switch can be used to set the address when the BMS is used in parallel, and supports a total of 16 addresses from 0 to 15. Dry contact user control of external devices such as alarms and fans; CAN and RS485-1 are used for communication between BMS and inverter. RS485-2 is used to connect battery packs in parallel and communicate with the upper computer, The panel interface is described as follows (see the attachment for details).

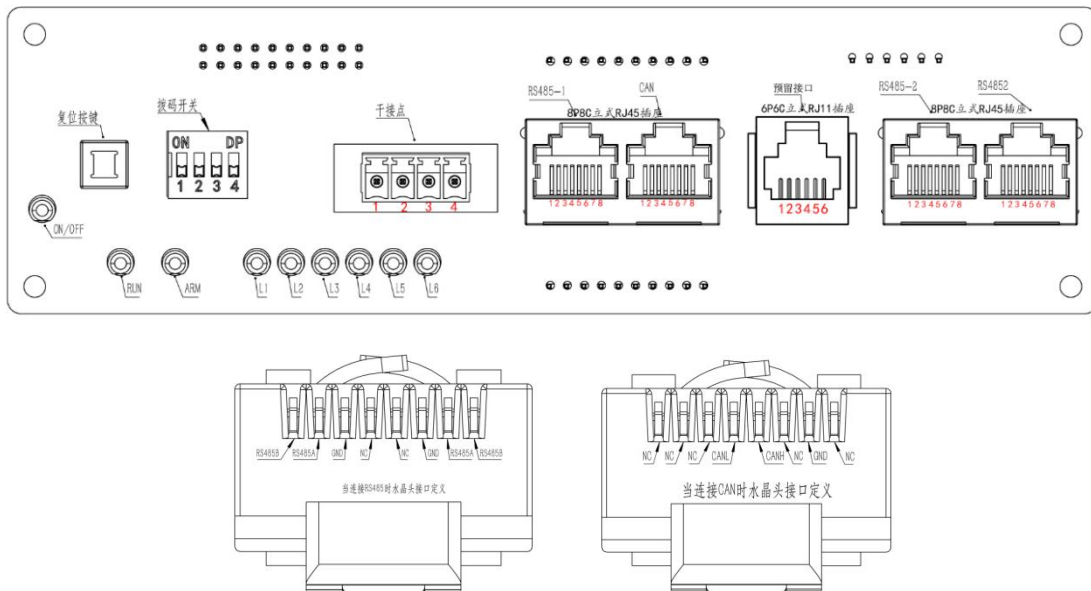

面板接口示意图  
 Panel interface diagram



## 4. 主要参数(Main parameter)

### 4.1. 基本参数(Basic parameterct )

序号 (Serial number)	项目 (Project)	具体参数 (argument)		单位 (Unit)
1	供电电压 (Supply voltage)	20-70		V
2	待机功耗 (Standby power consumption)	12		mW
3	运行功耗 (Operating power consumption)	1100		mW
4	工作温度 (Operating temperature)	-30-70		℃
5	最大采集串数 (Maximum number of collection strings)	16		串 (S)
6	最大均衡电流 (Maximum balancing current)	1		A
		2		
7	最大充电电流 (Maximum charging current)	10P	100	A
		15P	150	
		20P	200	
8	最大放电电流 (Maximum discharge current)	10P	100	A
		15P	150	
		20P	200	
9	最大瞬时电流 (Maximum instantaneous current)	10P	200	A
		15P	300	
		20P	400	
10	最大回路内阻 (Maximum internal loop resistance)	10P	1	mΩ
		15P	0.45	
		20P	0.35	
11	保护板尺寸 (Protective plate size)	300*100*18		mm
12	成品重量 (Finished weight)	1000		g

## 4.2. 默认参数(Default parameters)

序号 NUM	参数 PARA	三元默认 LI-ION	铁锂默认 LIFEPO4	钛酸锂默认 LTO	单位 (unit)
1	均衡起始电压 (balancing initial voltage)	3	3	2	V
2	最大均衡电流 (Maximum balancing current)	1	1	1	A
		2	2	2	A
3	单体过充电压 (Unit overcharge voltage)	4.2	3.6	2.7	V
4	单体过充保护恢复 (Single overcharge protection recovery)	4.17	3.54	2.64	V
5	单体欠压保护 (Monomer undervoltage protection)	2.82	2.6	1.8	V
6	单体欠压保护恢复 (Single undervoltage protection recovery)	2.85	2.65	1.85	V
7	自动关机电压 (Automatic shutdown voltage)	2.8	2.5	1.7	V
8	SOC-0%电压 (SOC-0% voltage)	2.9	2.6	1.85	V
9	SOC-100%电压 (SOC-100% voltage)	4.18	3.5	2.65	V
10	触发均衡压差 (Trigger balancing differential pressure)	0.01	0.01	0.01	V
11	充电过流保护延时 (Charging overcurrent protection delay)	3	3	3	秒 (S)
12	充电过流保护解除时间 (Charge overcurrent protection release time)	60	60	60	秒 (S)
13	放电过流保护延时 (Discharge overcurrent protection delay)	300	300	300	秒 (S)
14	放电过流保护解除时间 (Discharge overcurrent protection release time)	60	60	60	秒 (S)

15	短路保护延时 (Short-circuit protection delay)	1500	1500	1500	微秒 (uS)
16	短路保护解除时间 (Short circuit protection release time)	60	60	60	秒 (S)
17	充电过温保护温度 Charging overtemperature protection temperature	70	70	70	°C
18	充电过温恢复温度 (Charge overtemperature restore temperature)	60	60	60	°C
19	放电过温保护温度 (Discharge overtemperature protection temperature)	70	70	70	°C
20	放电过温恢复温度 (Discharge overtemperature recovery temperature)	60	60	60	°C
21	充电低温保护温度 (Charging low temperature protection temperature)	-20	-20	-20	°C
22	充电低温恢复温度 (Charge low temperature to restore temperature)	-10	-10	-10	°C
23	MOS 过温保护温度 (MOS Overtemperature protection temperature)	100	100	100	°C
24	MOS 过温保护恢复温度 (MOS Overtemperature protection recovery temperature)	80	80	80	°C
25	设备地址 (Device address)	0	0	0	/
26	放电预充时间 (Discharge precharge time)	0	0	0	秒 (S)

## 5. 接口定义(Interface definition)

### 5.1. 产品外形 (Product Appearance)

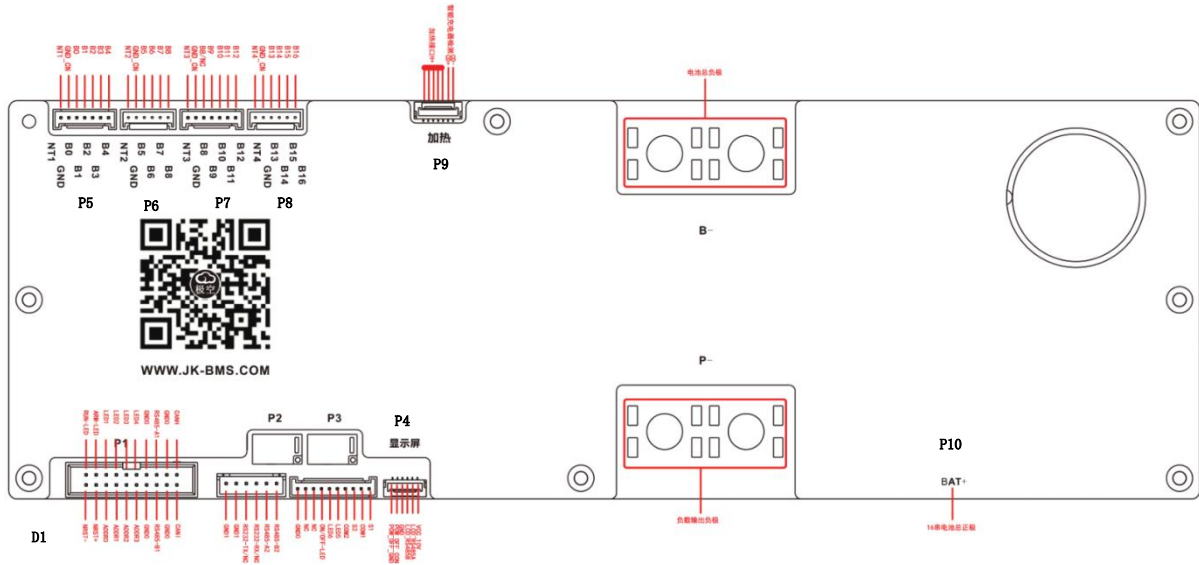

JK-PB1/2A16S-10/15/20P 连接器示意图

Schematic diagram of the JK-PB1/2A16S-10/15/20P connector

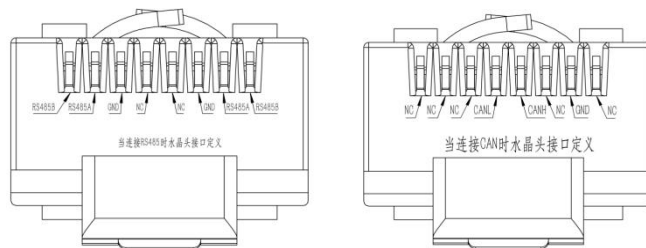
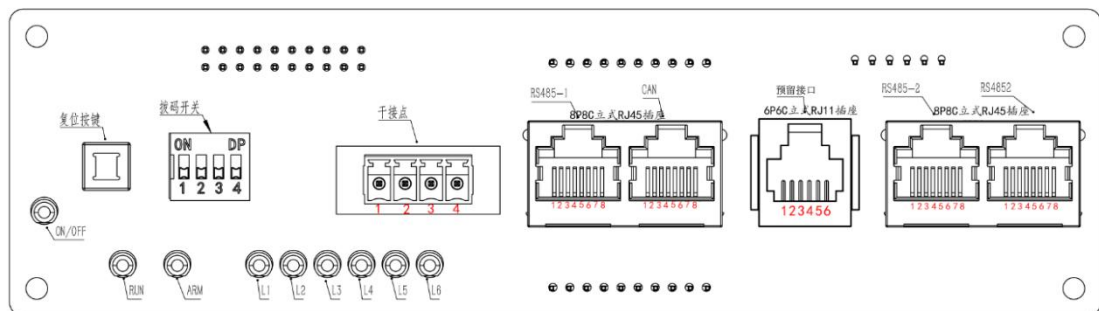

接口板接口示意图

Interface board interface diagram

## 5.2. 产品连接器、LED 定义(Product connector, LED definition)

### 接口定义(Interface definition)

连接器 (coupler)	连接器型号 (Type of connector)	接口名称 (Interface name)	管脚号 (Pin number)	JK-PB1/2A16S-10/15/20P	
				名称 (Name)	定义 (definition)
P1	简牛-2.54-2*10P	接口板接口 (Interface board interface)			
P2	XH-2.54-6P				
P3	HY-2.0-10P				
P4	A1254WF-6A	显示屏接口 (Display interface)	1	K-	激活信号负极(Activation signal negative electrode)
			2	K+	激活信号正极(Activate the positive signal)
			3	GND	电源负极(Negative terminal)
			4	B	显示屏RS485-B(The display RS485 signal is positive)
			5	A	显示屏RS485-A(Display RS485 signal negative)
			6	VCC	显示屏电源输出(Display power output)
P5	HY2.0-7P	采集接口 (Acquisition interface)	1	NT1	接NTC1温度探头(Connect the NTC1 temperature probe)
			2	GND	接NTC1温度探头(Connect the NTC1 temperature probe)
			3	B0	电池总负极(Total negative battery)
			4	B1	第 1 串电池正极(The first battery positives)
			5	B2	第 2 串电池正极(The second battery positive)
			6	B3	第 3 串电池正极(The third battery positive)
			7	B4	第 4 串电池正极(The fourth battery positive)
P6	HY2.0-6P	采集接口 (Acquisition interface)	1	NTC2	接NTC2温度探头 (Connect the NTC2 temperature probe)
			2	GND	接NTC2温度探头 (Connect the NTC2 temperature probe)
			3	B5	第 5 串电池正极(The fifth battery positive)
			4	B6	第 6 串电池正极(The sixth battery positive)
			5	B7	第 7 串电池正极(The seventh battery positive)
			6	B8	第 8 串电池正极(The eighth battery positive)
P7	HY2.0-7P	采集接口 (Acquisition interface)	1	NT3	接NTC3温度探头 (Connect the NTC3 temperature probe)

		interface)	2	GND	接NTC3温度探头 (Connect the NTC3 temperature probe)
			3	B8	预留管脚(reserved pin)
			4	B9	第 9 串电池正极(The ninth battery positive)
			5	B10	第 10 串电池正极(The tenth battery positive)
			6	B11	第 11 串电池正极(The eleventh battery positive)
			7	B12	第 12 串电池正极(The twelfth battery positive)
P8	HY2.0-6P	采集接口 (Acquisition interface)	1	NT4	接NTC4温度探头(Connect the NTC4 temperature probe)
			2	GND	接NTC4温度探头(Connect the NTC4 temperature probe)
			3	B13	第 13 串电池正极(The thirteenth battery positive)
			4	B14	第 14 串电池正极(The fourteenth battery positive)
			5	B15	第 15 串电池正极(The fifteenth battery positive)
			6	B16	第 16 串电池正极(The sixteenth battery positive)
P9	A1254WF-7A	加热接口 (Heating interface)	1-5	H+	加热负极(Power output, the voltage is close to B+)
			6	CD+	充电指示输入正极(Charge indication input positive terminal)
			7	CD-	充电指示输入负极(Charge indication input negative terminal)
P10	M3螺丝 (M3 screw)	电源输入 (Power input)	1	B+	电源输入正极(The power input is positive)
D1	蓝牙连接指示灯，当蓝牙连接上保护板时指示灯常亮，断开连接时指示灯闪烁。 (Bluetooth connection indicator: When the Bluetooth is connected to the protection board, the indicator is steady on, and when the connection is disconnected, the indicator is blinking.)				
P-	接外部负载或者充电器负极，M6螺丝 (Connect to external load or negative terminal of charger, M6 screw)				
B-	接电池负极，M6螺丝 (Connect to the negative battery terminal, M6 screw)				

**接口板接口定义 (Interface board Interface definition)**

干接点接口定义( Definition of a dry contact interface)		
引脚序号( Pin number)	引脚定义( Pin definition)	备注( remark)
1	COM1	
2	S1	
3	COM2	
4	S2	
CAN和RS485-1接口定义( Interface definition of CAN and RS485-1)		
引脚序号( Pin number)	引脚定义( Pin definition)	备注( remark)
1、 8	RS485- B1	
2、 7	RS485-A1	
3、 6	GND	
4、 5	NC	
1、 2、 3、 6、 8	NC	
4	CANL	
5	CANH	
7	GND	
预留接口定义( Reserved interface definition)		
引脚序号( Pin number)	引脚定义( Pin definition)	备注( remark)
1-6	NC	预留接口，暂未使用
RS485-2接口定义( Interface definition of RS485-2)		
引脚序号( Pin number)	引脚定义( Pin definition)	备注( remark)
1	RS485- B2	
2	RS485-A2	
3	GND	
4	NC	

5	NC	
6	GND	
7	RS485-A2	
8	RS485-B2	

**拨码开关设置**  
**(Dip switch Settings)**

地址(address)	拨码开关位置(Dip switch position)			
	1	2	3	4
0	OFF	OFF	OFF	OFF
1	ON	OFF	OFF	OFF
2	OFF	ON	OFF	OFF
3	ON	ON	OFF	OFF
4	OFF	OFF	ON	OFF
5	ON	OFF	ON	OFF
6	OFF	ON	ON	OFF
7	ON	ON	ON	OFF
8	OFF	OFF	OFF	ON
9	ON	OFF	OFF	ON
10	OFF	ON	OFF	ON
11	ON	ON	OFF	ON
12	OFF	OFF	ON	ON
13	ON	OFF	ON	ON
14	OFF	ON	ON	ON
15	ON	ON	ON	ON

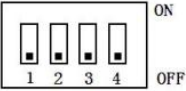



**LED说明 (LED description)**

状态 (status)	正常/告警/保护 (Normal, alarm, or Protection)	ON/OFF F指示	RUN	ALM	L1	L2	L3	L4	L5	L6	说明 (Instructions)
关机 (Power Off)	正常(normal)	OFF									
Balance	正常(normal)	ON	闪烁 (flicker)	OFF	依据电量显示(Battery based display)					OFF	
充电 (charging)	正常(normal)	ON	闪烁 (flicker)	OFF	依据电量显示(Battery based display)					OFF	
	过流\过温\过压 \充电失败(Over current, over temperature, over voltage, charging failure)	ON	闪烁 (flicker)	闪烁 (flicker)	依据电量显示(Battery based display)					OFF	
放电 (discharge)	正常(normal)	ON	闪烁 (flicker)	OFF	依据电量显示(Battery based display)					OFF	
	过流\过温\欠压 \放电失败(Over current, over temperature, under voltage, discharge failure)	ON	闪烁 (flicker)	闪烁 (flicker)	依据电量显示(Battery based display)					OFF	
其他告警 (Other alarm)	密码未修改\短 路\温度异常 (Password not changed \ short circuit \ temperature	ON	闪烁 (flicker)	闪烁 (flicker)	依据电量显示(Battery based display)					OFF	

abnormal)							
备注：当设备地址设置为0时做主机，最后一颗LED灯 L6闪烁。当设为其他值时做从机熄灭，从机和主机通信成功后闪烁 Note: When the device address is set to 0, the last LED indicator L6 blinks. If the value is set to other values, the slave is off and blinks after the communication between the slave and the host is successful.							
备注：ON代表LED状态为亮，OFF代表LED状态为熄灭。 Note: ON indicates that the LED is on,OFF indicates that the LED is off.							

**电量LED说明**  
(Power LED Description)

状态(status)		充电(charging)					放电(discharge)				
容量指示灯(capacity indicator light)		L5	L4	L3	L2	L1	L5	L4	L3	L2	L1
电量(Electric quantity)%	0~20%	OFF	OFF	OFF	OFF	ON	OFF	OFF	OFF	OFF	ON
	20~40%	OFF	OFF	OFF	ON	ON	OFF	OFF	OFF	ON	ON
	40~60%	OFF	OFF	ON	ON	ON	OFF	OFF	ON	ON	ON
	60~80%	OFF	ON	ON	ON	ON	OFF	ON	ON	ON	ON
	80~100%	ON	ON	ON	ON	ON	ON	ON	ON	ON	ON
备注：ON代表LED状态为亮，OFF代表LED状态为熄灭 Note: ON indicates that the LED is on, OFF indicates that the LED is off											

### 5.3. 产品尺寸(Product size)

JK-PB1/2A16S-10/15/20P系列保护板尺寸为 300mm×100mm×18mm如下图所示(详情见附件):

The size of JK-PB1/2A16S-10/15/20P series protection board is 300mm×100mm×18mm as shown in the following figure(See annex for details):

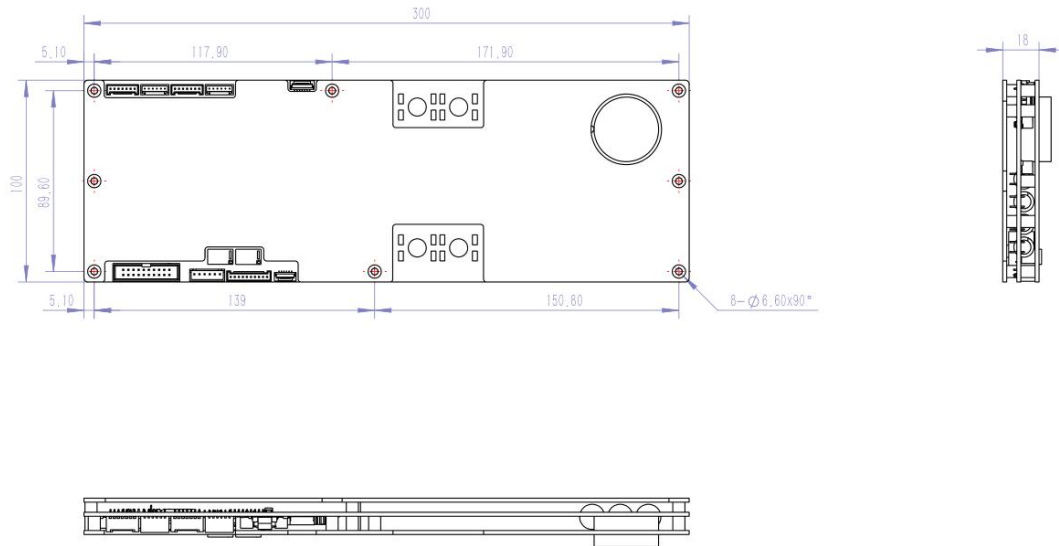

JK-PB1/2A16S-10/15/20P 外形尺寸  
 Dimensions of JK-PB1/2A16S-10/15/20P

单位: mm

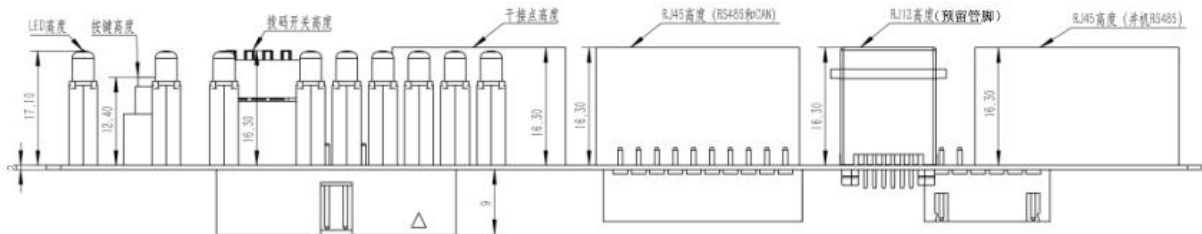
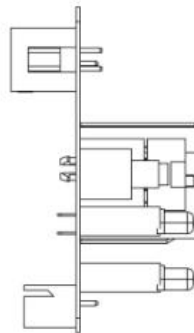
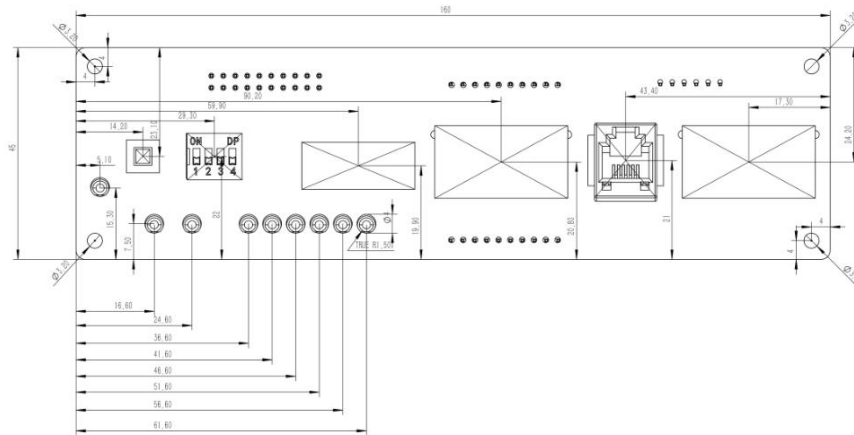
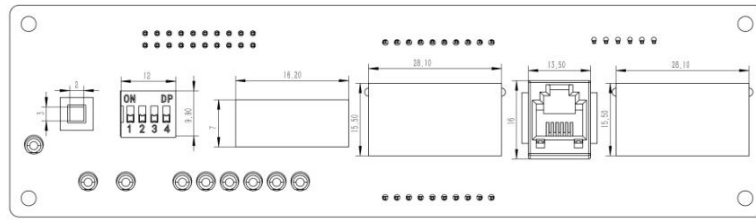

接口板 外形尺寸

Dimensions of the interface board

## 5.4. 安装方法 (Installation method)

JK-PB1/2A16S-10/15/20P系列保护板适用于7-16串的的锂电池组，不同电芯数量的电池组接线方法不同，具体接线方式如下图所示(详情见附件)。

JK-PB1/2A16S-10/15/20P series protection board is suitable for 7-16 series of lithium battery pack, different cell number of battery pack wiring methods are different, the specific wiring method is shown in the following figure(See annex for details).

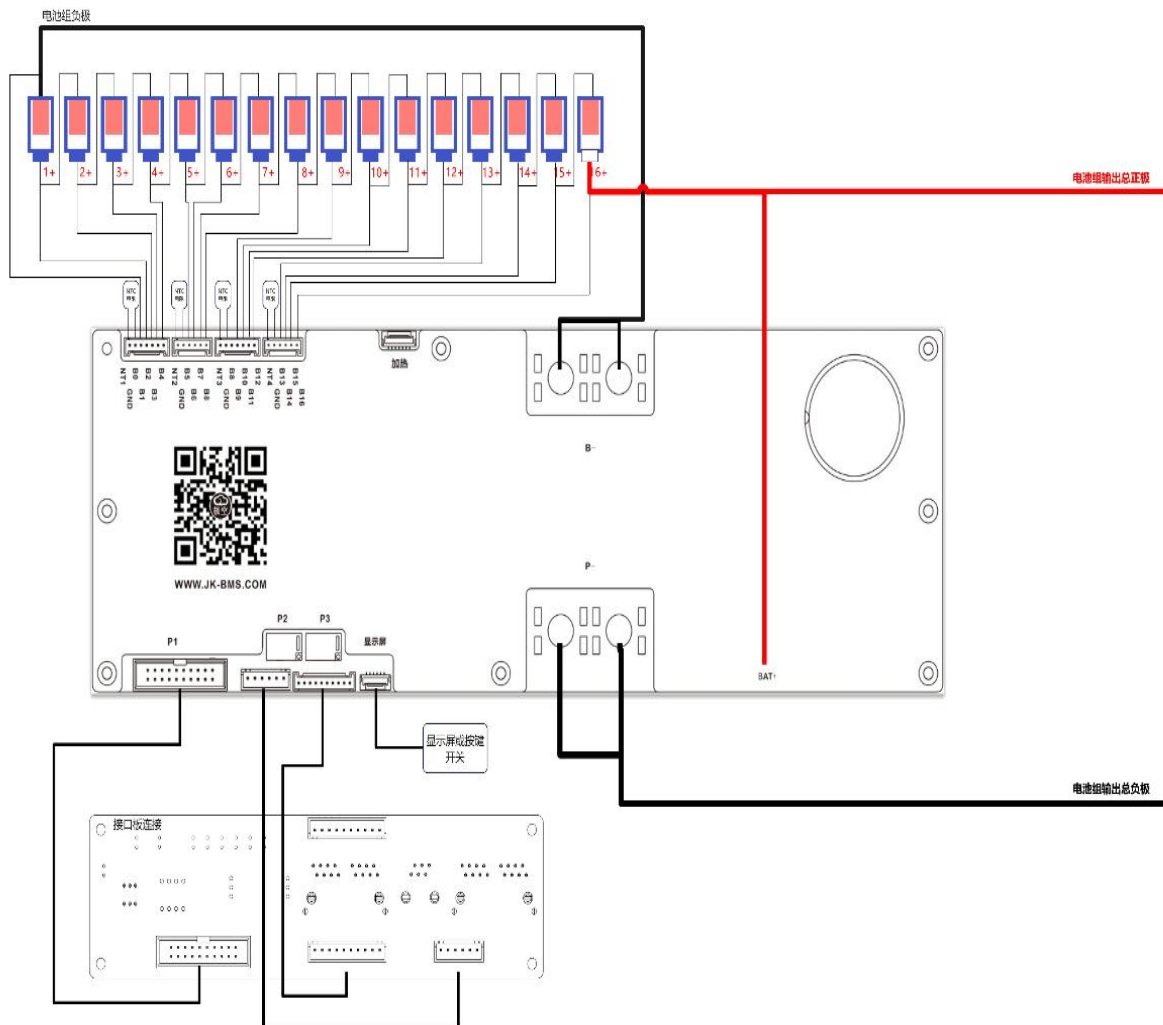

JK-PB1/2A16S-10/15/20P 接线图  
 JK-PB1/2A16S-10/15/20P wiring diagram

## 6. 设备使用说明(APP operation Instructions)

### 6.1. APP安装 (APP installation)

通过扫描下图所示的二维码可以获取与产品配套的手机APP

Mobile APP matching the product can be obtained by scanning the QR code shown in Figure . Android Version 7 minimum is required for the Android APP.



手机APP 链接二维码

Mobile APP link QR code

## 6.2. 设备激活(Device activation)

在保护板开机之前，请再次确认均衡线连接是否正常，“P-”与“B-”是否连接正确。检查保护板是否已经稳妥的与电芯固定，确认无误后才可以接通给保护板上电，否则可能造成工作异常、甚至烧毁等严重后果。

确认上述操作无误以后，可以给保护板上电。保护板没有上电控制开关，设计为充电激活模式(充电器电压比电池电压高 2V)，即电池组装完成以后需要接上充电器让保护板开机工作。

保护板激活除了充电激活以外还支持按键激活以及显示屏激活,选配显示屏以及按钮的用户只需将线缆插入显示屏接口，按下按键即可激活。

Before starting the protection board, check whether the balance cable is properly connected and whether P- and B- are correctly connected. Check whether the protection board has been securely fixed with the battery core, and confirm that it is correct before you can switch on the protection board, otherwise it may cause serious consequences such as abnormal work and even burning.

After confirming the preceding operations, power on the protection board. The protection board has no power-on control switch, and is designed for charging activation mode (the charger voltage is 2V higher than the battery voltage), that is, after the battery assembly is completed, the charger needs to be connected to make the protection board work.

In addition to charging activation, the protection board also supports key activation and display activation. Users who choose the display screen and button only need to insert the cable into the display interface and press the button to activate.

## 6.3. 参数设置(Parameter setting)

详见“保护板参数设置说明”。

Please refer to the "Instructions for Setting Protection Board Parameters" for details.